

Flowscape Roompanel T220 installation guide – installation on glass

1

Parts included in package

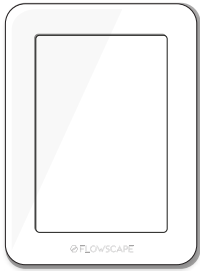

1x

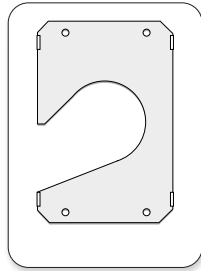

1x

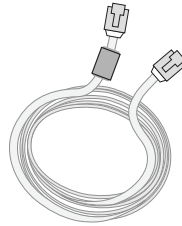

1x

Flowscape Roompanel T220, mounting plate with adhesive back and Ultra Thin 1mm ethernet cable.

2

Clean the glass



Clean the glass from any dirt, dust or grease using isopropanol or ethanol, then leave to dry.

3

Suggested height

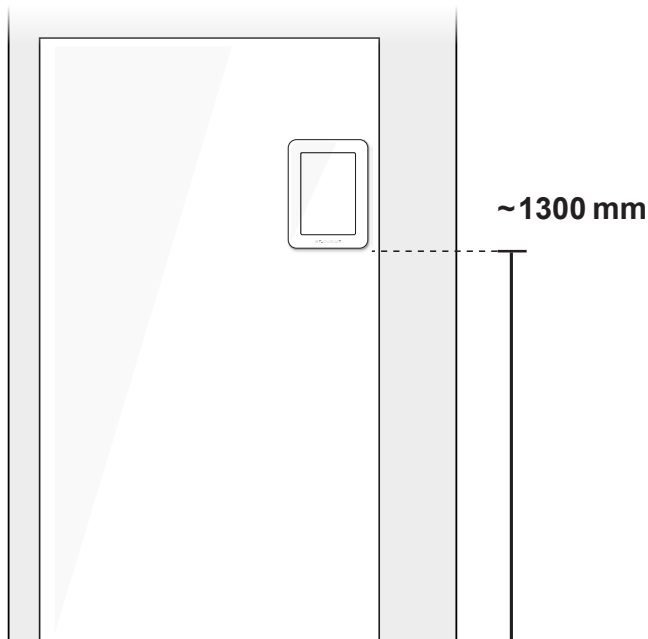

Preferably mount the roompanel close to the window edge to minimize visible cable routing. The cable can be routed in any direction.

4

Attach the mount plate to the glass

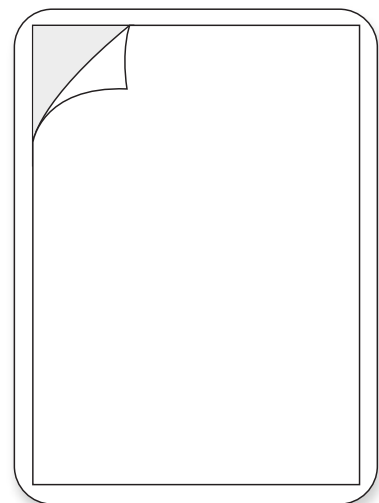

Peel off the protective film on the back and attach the mount plate to the glass.

Flowscape Roompanel T220 installation guide – installation on glass

5

Caution!

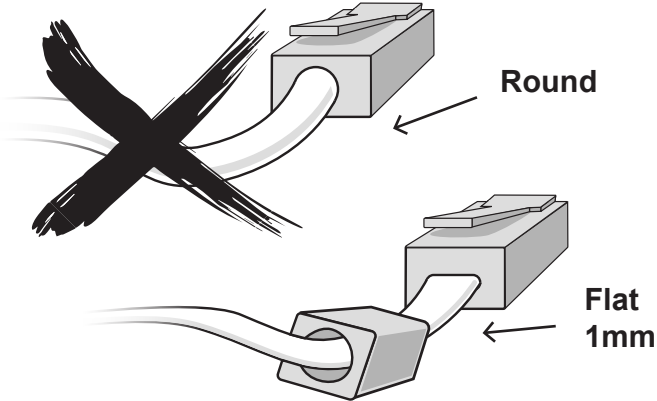

*Always use the included ULTRA THIN 1MM Flat cable.
Standard round ethernet cable will cause interference!*

7

**Hang panel &
route the cable**

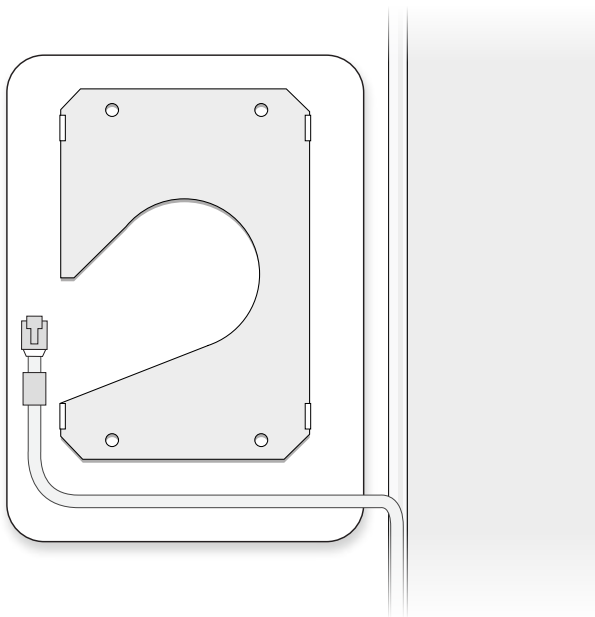

*The ultra thin 1mm cable can be slided and
hidden in between the plate and the roompanel.*

6

Please notice!

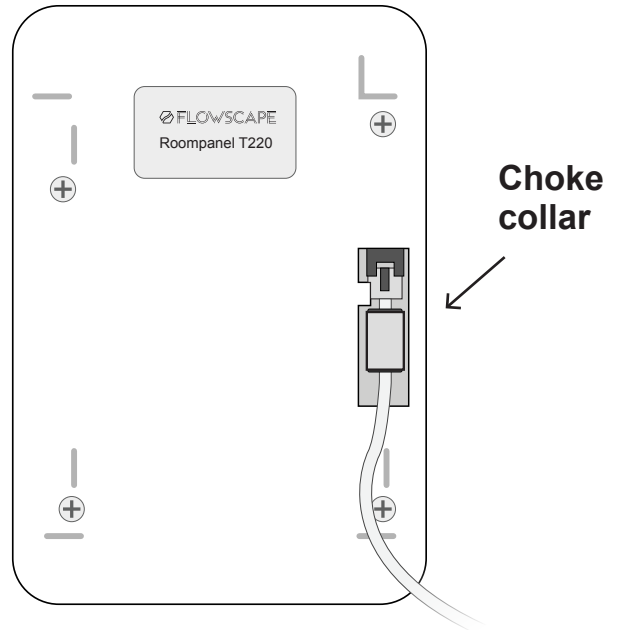

*Slip the choke collar of the included cable
into the cable pocket. (The choke is needed
to eliminate electromagnetic interference)*